

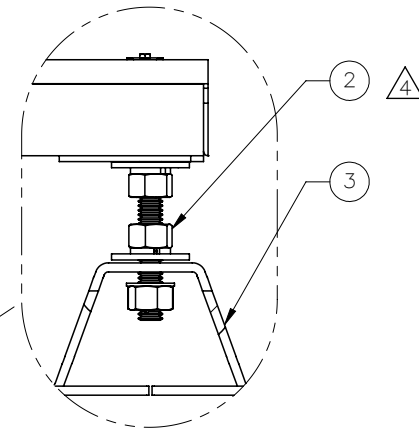

THE INFORMATION CONTAINED IN THIS DRAWING IS THE SOLE PROPERTY OF ELECTRO MECHANICAL INDUSTRIES, INC. ANY REPRODUCTION IN PART OR WHOLE WITHOUT THE WRITTEN PERMISSION OF ELECTRO MECHANICAL IND., IS PROHIBITED.

REVISIONS					
REV.	DCN #	DESCRIPTION	DATE	BY	APPROVED
4	01205	RODENT GUARD P-006-606 ADDED.	01/04/2023	JTR	JPB

SHOWN WITHOUT GRATING

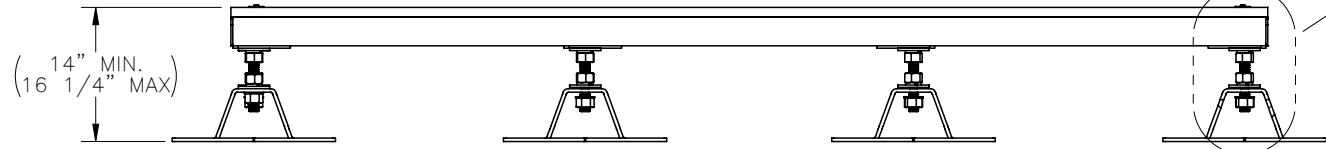
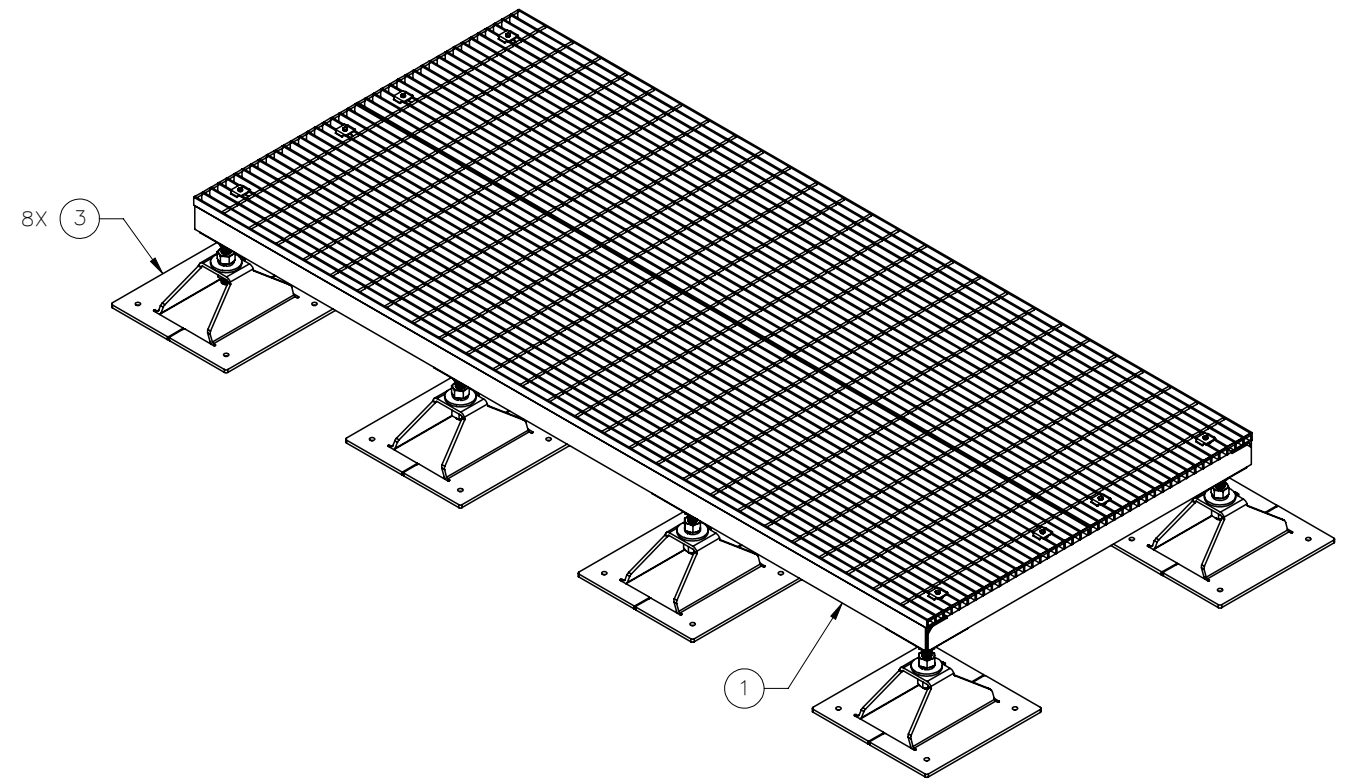
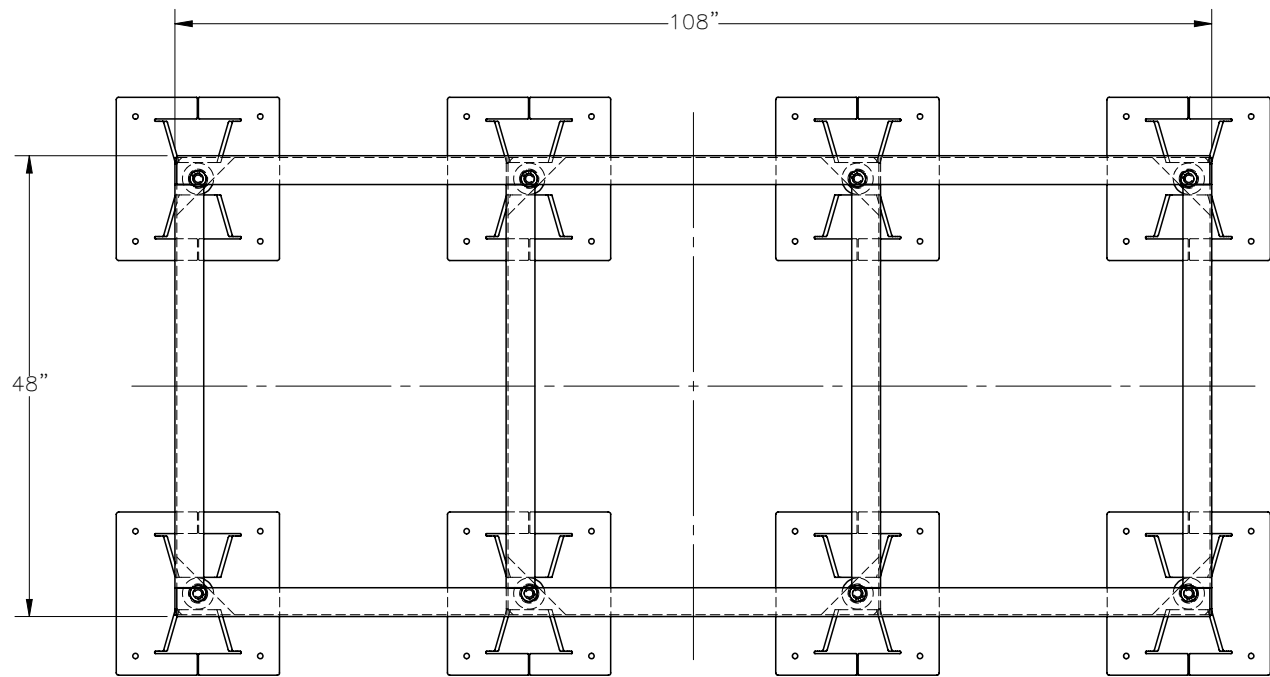

ITEM NO.	QTY REQD	PART NUMBER	DESCRIPTION	LENGTH	WEIGHT
1	1	1001-0020-0112	4' X 9' GENERATOR PLATFORM		392.9
2	8	1000-0020-0076	SINGLE MOUNT LEVELING HARDWARE KIT		4.682
3	8	P-004-838	FORMED FOOT		31.117
4	1	P-006-606	RODENT GUARD	36"	2.720

SURFACE FINISH <input checked="" type="checkbox"/> UNLESS OTHERWISE SPECIFIED		UNLESS OTHERWISE SPECIFIED DIMENSIONS ARE IN INCHES		APPROVALS		DATE		 ELECTRO MECHANICAL INDUSTRIES, INC. 11230 NEESESHAW DRIVE HOUSTON, TEXAS 77065 1-800-453-0050	
MATERIAL SEE PARTS LIST		TOLERANCES .0 ±.06 .00 ±.015 .000 ±.005		DRAWN J. CRITELLI		1/17/2019			
THIRD ANGLE PROJECTION 		FRACTIONS ± 1/16		CHECKER P. GUTIERREZ		1/17/2019		TITLE: 4' X 9' GENERATOR PLATFORM	
NEXT ASSY USED ON		ANGLES ± .25°		ENGINEER J. BREEN		1/17/2019			
APPLICATIONS		HOLES: DRILLED OR PUNCHED ± 1/32 BURNED ± 1/32		PRODUCTION J.K.S.		1/18/2019		SIZE B DRAWING NO. 1001-0020-0062 REV 4	
				SCALE: 1:20		WEIGHT: 682.0 lbs.		SHEET 1 OF 1	

- NOTES:
-  OPTIONAL PLATE PROVIDED IF REQUIRED FOR GENERATOR.